

# Instructions

## Contents

1. PegBoard PX™
2. Self-Stick Spacer™:
  - Spacers
  - Adhesive Dots

## Installation Instructions

1. Fasten onto wall using peg hook holes for mounting
2. Locate mounting holes to structural wall components (ie wall studs) wherever possible.
- 3. Use holes shown in red in illustrations below.
- ⊙ 4. Use any remaining holes for mounting into structural wall components (ie wall studs) - shown in green in illustrations below.
5. Use as many structural wall components (ie wall studs) as possible.
6. Remove clear plastic liner from adhesive dots.
7. Press spacer to adhesive dot, then press spacer to desired location on PegBoard PX™
8. Do not over tighten screws.

### Fastening into wall stud

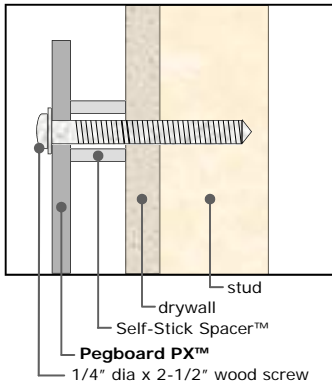

### Fastening into hollow wall

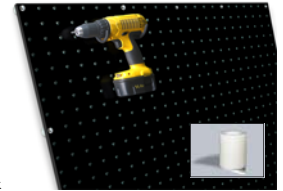
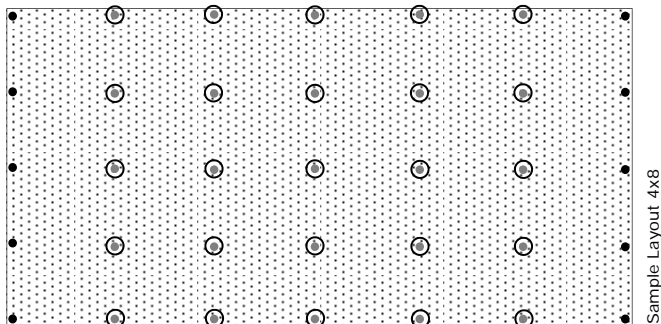
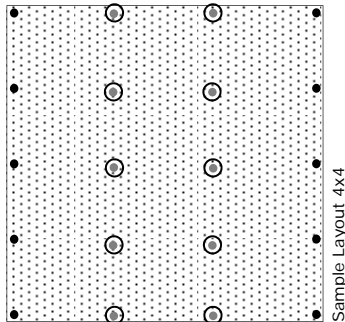
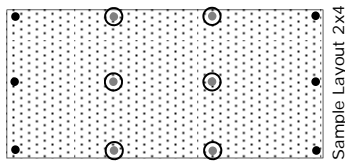
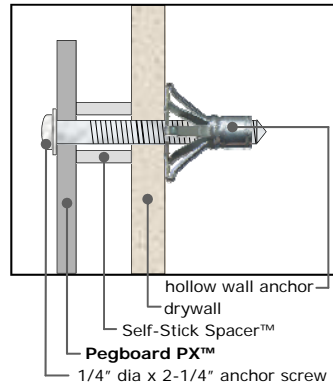

Black

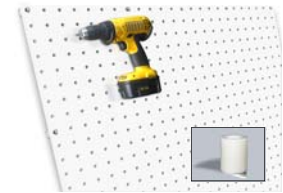

White

PegBoard PX™  
P/N: HPBPX

Any questions or problems, please contact us:

Gupta Permold Corporation  
Consumer Goods Division  
diamondLife™ Brand  
234 Lott Road  
Pittsburgh, PA 15235  
USA  
Ph. 412.793.3511 x103  
Fx. 412.793.1055  
Email. [help@diamondlifegear.com](mailto:help@diamondlifegear.com)  
Store. [diamondlifegear.com](http://diamondlifegear.com)



Find hundreds of more great work space enhancement products at [www.diamondlifegear.com](http://www.diamondlifegear.com)

## Accessories



Peg Hooks



Baskets



Bins



Organizers



Mounting Fasteners



Self-Stick Spacers™

## Cleaning

Regular cleaning can be done with soap and water, any commercial window glass cleaner, or Alcohol Acetone for stubborn areas. Use a soft cloth or damp paper towel. Abrasive materials will scratch the surface. If an external surface static charge develops, spraying an anti-static solution on the affected area will eliminate the problem.

 diamondLife™