

Instructions

Contents

1. PegBoard PX™
2. Self-Stick Spacer™:
 - Spacers
 - Adhesive Dots

Installation Instructions

1. The PegBoard PX™ is mounted using a "grid" of mounting points positioned appx 16" on-centers.
2. Position the PegBoard PX™ onto your wall and determine which mounting points fall on structural wall components (ie wall studs) - these locations can use screws for mounting, and locations that do not fall onto wall studs will require anchors. Use as many structural wall components (ie wall studs) as possible.
3. Use the peg holes as the mounting holes. After determining which peg holes will be used for mounting, place a Self-Stick Spacer on the backside of those peg holes.
4. To install Self-Stick Spacers, remove the clear plastic liner from the adhesive dots, and press the spacer to the adhesive dot, and then press the spacer to the desired location on PegBoard PX™.
5. Your mounting screw should go thru the PegBoard PX™, thru the Self-Stick Spacer, and then into your wall.
6. See example mounting patterns for common sizes, in illustrations below.
7. Do not over tighten screws.

Fastening into wall stud

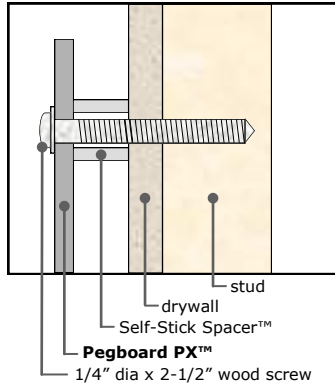

Fastening into hollow wall

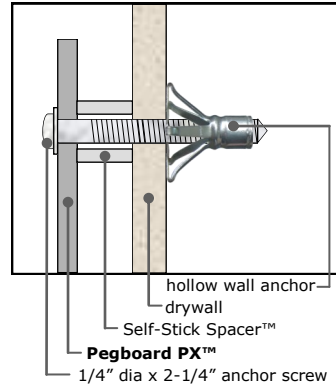

- ⊙ Mounting points on a structural wall components (ie wall studs)
- Mounting points in hollow wall

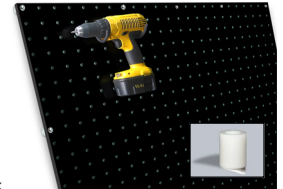
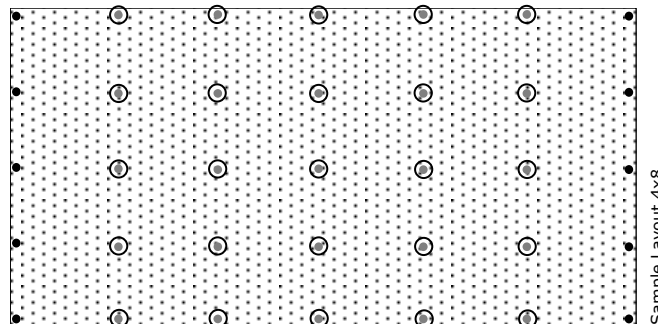
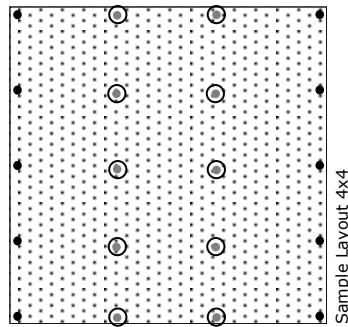
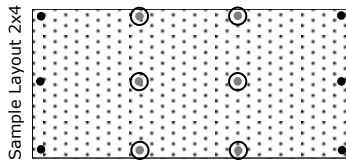

Black

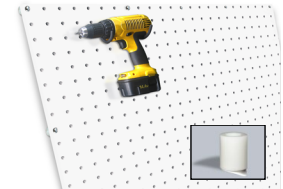

White

PegBoard PX™
P/N: HPBPX

Any questions or problems, please contact us:

diamondLife
234 Lott Road
Pittsburgh, PA 15235
USA

Ph. 1.888.98.DGEAR (983.4327)
Email. help@diamondlifegear.com
Store. diamondlifegear.com

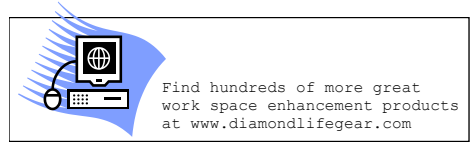

Accessories



Peg Hooks



Baskets



Bins



Organizers



Mounting Fasteners



Self-Stick Spacers™

Cleaning

Regular cleaning can be done with soap and water, any commercial window glass cleaner, or Alcohol Acetone for stubborn areas. Use a soft cloth or damp paper towel. Abrasive materials will scratch the surface. If an external surface static charge develops, spraying an anti-static solution on the affected area will eliminate the problem.

Doing a common thing uncommonly well, brings success.

Welcome to the diamondLife.™

