

Instructions

Contents

1. PegBoard HB™
2. Self-Stick Spacer™:
 - Spacers
 - Adhesive Dots

Installation Instructions

1. The PegBoard HB™ is mounted using a "grid" of mounting points positioned at 16" on-centers.
2. Position the PegBoard HB™ onto your wall and determine which mounting points fall on structural wall components (ie wall studs) - these locations can use screws for mounting, and locations that do not fall onto wall studs will require anchors. Use as many structural wall components (ie wall studs) as possible.
3. Use the peg holes as the mounting holes. After determining which peg holes will be used for mounting, place a Self-Stick Spacer on the backside of those peg holes.
4. To install Self-Stick Spacers, remove the clear plastic liner from the adhesive dots, and press the spacer to the adhesive dot, and then press the spacer to the desired location on PegBoard HB™.
5. Your mounting screw should go thru the PegBoard HB™, thru the Self-Stick Spacer, and then into your wall.
6. See example mounting patterns for common sizes, in illustrations below.
7. Do not over tighten screws.

Fastening into wall stud

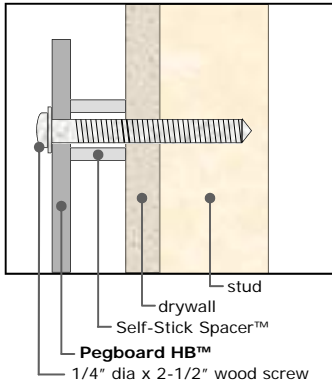

Fastening into hollow wall

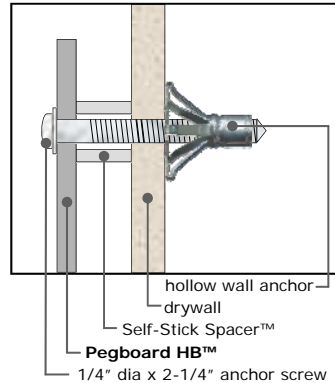

- ⊙ Mounting points on a structural wall components (ie wall studs)
- Mounting points in hollow wall

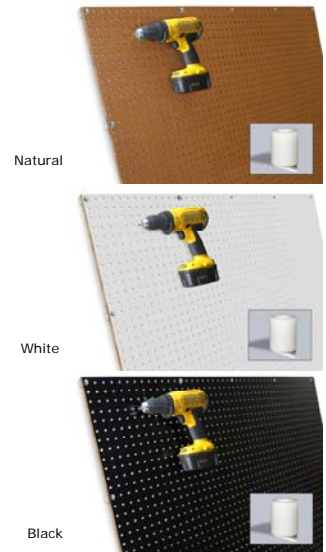
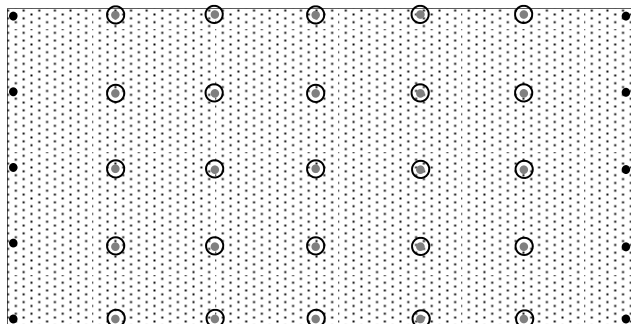
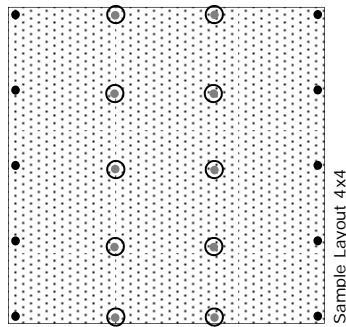
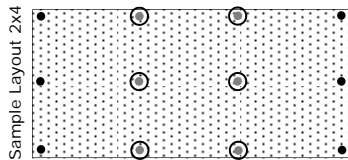

PegBoard HB™
P/N: HPBW

Any questions or problems, please contact us:

diamondLife
234 Lott Road
Pittsburgh, PA 15235
USA

Ph. 1.888.98.DGEAR (983.4327)
Email. help@diamondlifegear.com
Store. diamondlifegear.com



Find thousands of more great work space enhancement products at www.diamondlifegear.com

Accessories

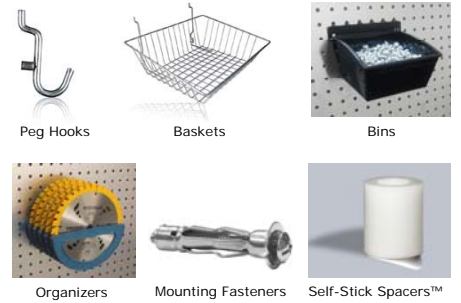

Doing a common thing uncommonly well,
brings success.

Welcome to the diamondLife.™